

VOYAGER BLADE SURFACE

THORN

EN Installation Instructions



1. Installation to be carried out by a qualified electrician in accordance with local wiring regulations. Ensure that the rated voltage and frequency of the luminaire are compatible with the electrical supply.
2. Disconnect mains supply before installing, servicing or maintaining the luminaire.
3. The manufacturer, shall not be liable for any damage resulting from inappropriate modifications to the luminaire or faulty installation.



4. The light source contained in this luminaire shall only be replaced by the manufacturer or their service agent or a similar qualified person.
5. The light source can't be replaced. The control gear provides basic insulation between the LV supply and the control circuit.
6. Specification: These luminaires are designed to comply with the requirements of AS/NZS 60598 and AS/NZS 2293.

SAP code	Product Description	EAN
96294579	VOYAGER BLADE SURFACE 24M E2M	9415167080238

Length*Width*Height	350*73*220
Power consumption	3W
Input Voltage	220-240V AC, 50/60Hz
Battery	Lithium-iron phosphate (LiFePO4)
Charging time	16 hours
Autonomy	3 hours
Temperature	0°C to 40°C
Operating mode	Maintained with manual test switch
Viewing distance	24m (for single or double sided viewing)
Spacing classification	C0=D8, C90=D4
Ingress protection	IP40
Material/finish	Polycarbonate
Mounting	Ceiling, Wall
Warranty	5 years luminaire, 3 years battery

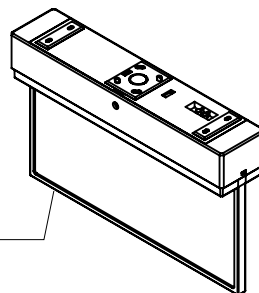
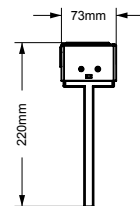
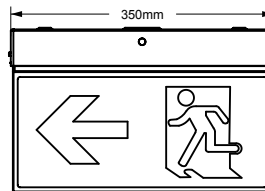

1	x1
2	x1
3	x1
4	x1
5	x1

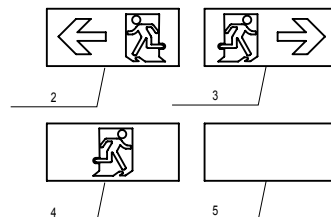

1

Determine Location

In accordance with the relevant parts of AS/NZS 2293 determine a suitable location for installation.

2

Attach the Signage Screens

Ensure that hands are clean and no dirt or dust can be trapped beneath the screens. Determine the appropriate signage screens to use based on the luminaire installation location.

NB- Take care not to crease the sign media or damage the edges. Ensure the signage points in the correct orientation.

To insert the screen gently slide into the top cavity of the diffuser panel and gently bend and slide into position observing the diffuser brackets on the sides and bottom.

Gently pull the bottom diffuser bracket downwards to assist fitting or removing screens.

3

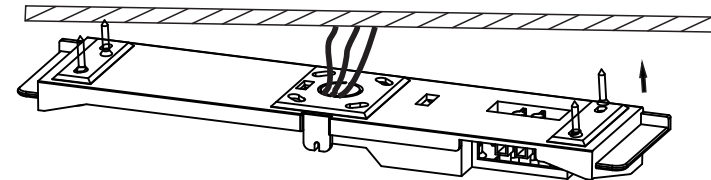

Remove the plate by sliding it away. Mount the plate to the ceiling or wall.

4

Unscrew the cover for the terminal block.

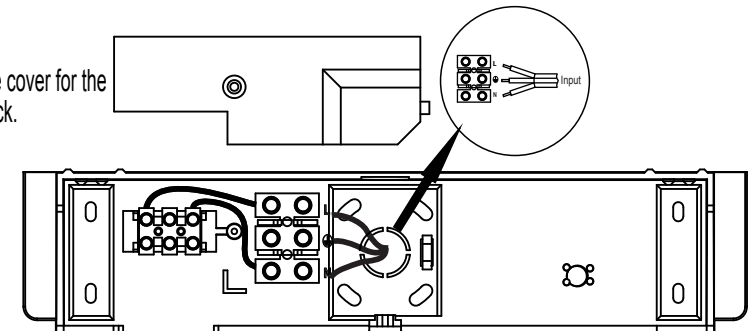

Connect wiring to the terminals, then secure the cover back on.



IP40 IK07



VOYAGER BLADE SURFACE

THORN

5

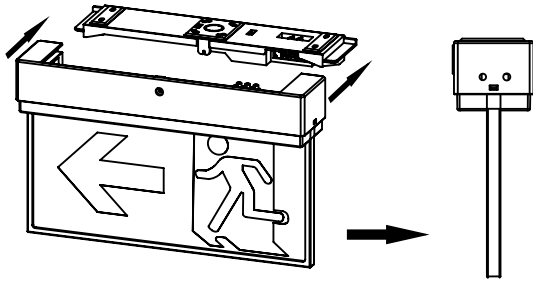

Assemble the product by sliding the body into place.

6

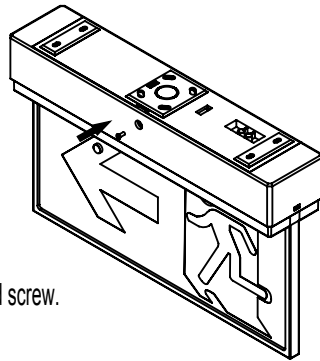

Secure the plate and body using the supplied screw.

7

Test The Luminaire

When the internal batteries have a period of time to charge, the test switch on the side of the luminaire will allow you to spot check correct functionality. The charge indicator illuminates when in operation.

In accordance with the requirements of AS/NZS 2293, once the luminaire is installed and fully charged, you will need to conduct a commissioning discharge test.

The Australian, New Zealand standards require newly installed emergency luminaires to operate in emergency mode for 2 hours.

Subsequent maintenance testing is required every 6 months and testing is required to be recorded in a suitable service logbook.

