

# Aerie

# THORN

96632762 ARW 12L70-740 WSC CL CL2 W5 T60 ANT



## Aerie

A discreet, post top LED lantern with a timeless design. LED driver for 12 LEDs, driven at 700mA with Wide Street Comfort (asymmetrical) distribution. Class II electrical, IP66, IK10. Canopy and base: corrosion resistant die-cast powder coated aluminium suitable for C5 environments, finished textured anthracite (close to RAL7043). Enclosure: wide UV stabilised polycarbonate with clear finish. Complete with 4000K LED. Post top mounting to  $\varnothing 60$ mm column. Pre-wired with 5m cable.

Dimensions:  $\varnothing 602 \times 586$  mm  
Luminaire input power: 27 W  
Luminaire luminous flux: 3960 lm  
Luminaire efficacy: 147 lm/W  
Weight: 10.95 kg  
Scx: 0.172 m<sup>2</sup>



TLG\_AERI\_F\_W\_CL.jpg

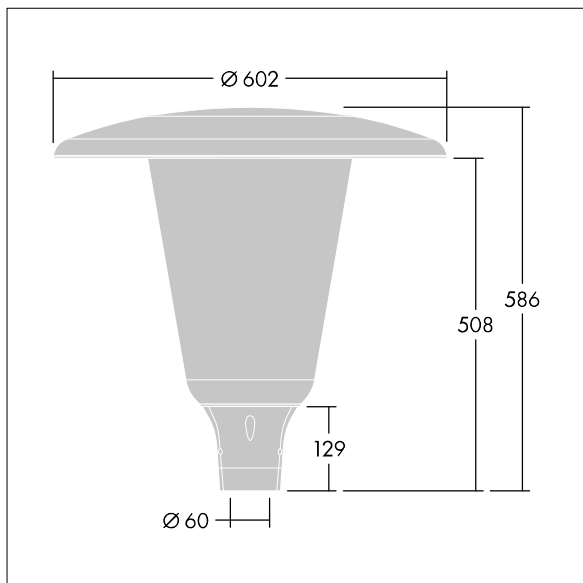

TLG\_AERI\_M\_T60\_W.wmf

This product contains a light source of energy efficiency class D.

All values marked with an \* are rated values. Thorn uses tried and tested components from leading suppliers, however there may be isolated instances of technology-related failures of individual LEDs during the rated product lifetime. International standards set the tolerance in initial flux and connected load at  $\pm 10\%$ . Unless stated otherwise, the values apply to an ambient temperature of 25°C.

Thorn Lighting is constantly developing and improving its products. The right is reserved to change specifications without prior notification or public announcement.  
© Thorn Lighting