

## Areaflood Pro

96644730 AFP S 24L50-740 A4 BS 3550 CL1 GY

ISO 9223 C5	IP66	IK08	⊕	⚠	⚙	⚙	⚙	T <sub>a</sub> -25 +35
----------------	------	------	---	---	---	---	---	---------------------------

### Areaflood Pro

A compact, lightweight, general purpose LED area floodlight. With small body, driving 24 LEDs at 500mA with asymmetrical 40° light distribution. IP66, IK08, Class I electrical. Body: die-cast aluminium (EN AC-44300), Light grey 150 sanded textured (close to RAL9006).. Enclosure: 4mm thick toughened glass. Reversible mounting stirrup supplied, Complete with 4000K LED.

Not compatible with UrbaSens systems.

Dimensions: 462 x 265 x 139 mm  
 Luminaire input power: 38 W  
 Luminaire luminous flux: 5877 lm  
 Luminaire efficacy: 155 lm/W  
 Weight: 6.2 kg  
 Scx: 0.05 m<sup>2</sup>



TLG\_AFLP\_F\_SMALLPDB.jpg

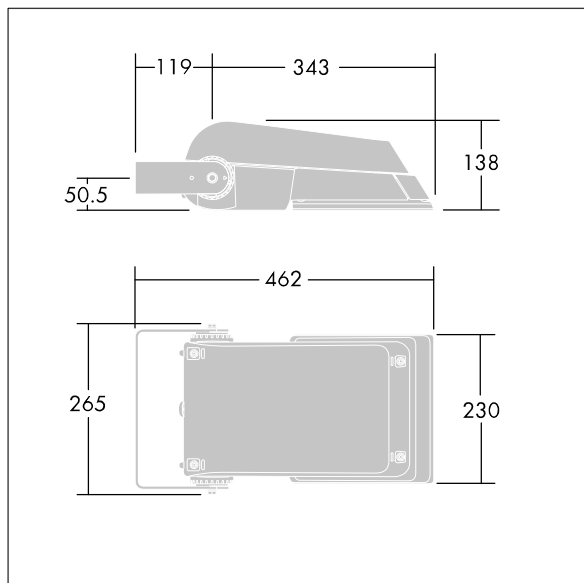

TLG\_AFLP\_M\_SML.wmf

This product contains light sources of energy efficiency class D.

All values marked with an \* are rated values. Thorn uses tried and tested components from leading suppliers, however there may be isolated instances of technology-related failures of individual LEDs during the rated product lifetime. International standards set the tolerance in initial flux and connected load at ±10%. Unless stated otherwise, the values apply to an ambient temperature of 25°C.