

Base Pro

96650618 BASE PRO 150 LED 2500-940 HFI WH FP

RoHS	↓ IP20 ↑ IP44	IK08			850 °C	T _a -20 +40
------	------------------	------	--	--	--------	---------------------------

Base Pro

A high performing, low height, recessed LED downlight. DALI dimmable LED driver. Body: die-cast aluminium, powder coated white. Reflector: matt aluminium. Diffuser: opal polycarbonate. Class II electrical, IP44_IP20, Impact strength: IK08. Spring clips suitable for quick installation. Cut-out: Ø150mm. Complete with 4000K LED. Fitted with flex and plug.. Note: UGR<19 for office applications compliant with CIE testing method.

Dimensions: Ø165 x 80 mm
 Luminaire input power: 29 W
 Luminaire luminous flux: 2580 lm
 Luminaire efficacy: 89 lm/W
 Weight: 0.9 kg



TLG_BASP_F_150.jpg

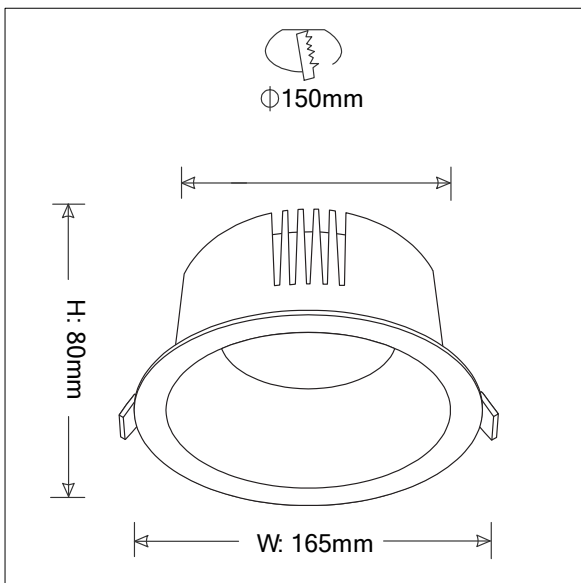

TLG_BASP_M_150.wmf

All values marked with an * are rated values. Thorn uses tried and tested components from leading suppliers, however there may be isolated instances of technology-related failures of individual LEDs during the rated product lifetime. International standards set the tolerance in initial flux and connected load at ±10%. Unless stated otherwise, the values apply to an ambient temperature of 25°C.

Thorn Lighting is constantly developing and improving its products. The right is reserved to change specifications without prior notification or public announcement.
 © Thorn Lighting