

## Altis Gen5

96671943 ALG5 GB 1368W 0.70A 565V 2CH RDMX

IP66	IK08				T <sub>a</sub> 45
------	------	--	--	--	-------------------

### Altis Gen5

Class I, DMX RDM programmable gearbox, with 2 independant output channels and IP66 enclosure, for TV broadcasting applications. Suitable for dedicated 288 / 312 / 336 LED Altis floodlight, to be installed remotely up to 200m from the floodlight. Nominal input voltage: 200-440, output current 700mA with DMX RDM configurable single-channel, IEEE 1789 flicker recommended practice compliant suitable for super slow motion camera filming, surge level 10kV for both common mode and differential.

Connection from mains via terminal blocks. Mains supply must be fused according to local safety regulations.

Weight: 5.4 kg.



TLG\_ALT5\_F\_GB\_1700.jpg

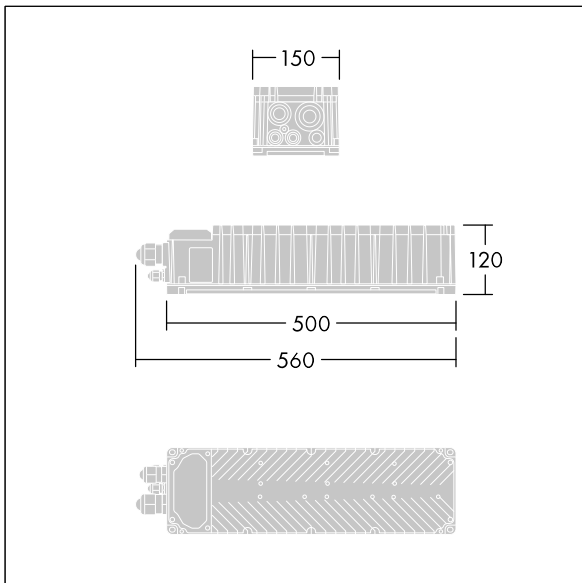

TLG\_ALT5\_M\_GB.wmf