

Wall-mounted luminaire

A contemporary wall mounted architectural LED luminaire for decorative facade lighting with asymmetric light distribution. Electronic, fixed output control gear. Class II electrical, IP65, IK06. Body: die-cast aluminium (EN AB-47100), powder coated textured black (close to RAL 9005), frosted tempered glass. Complete with 3000K LED.

Dimensions: 120 x 120 x 105 mm

Weight: 0.75 kg



TLG_ACUTO_F_LED.jpg

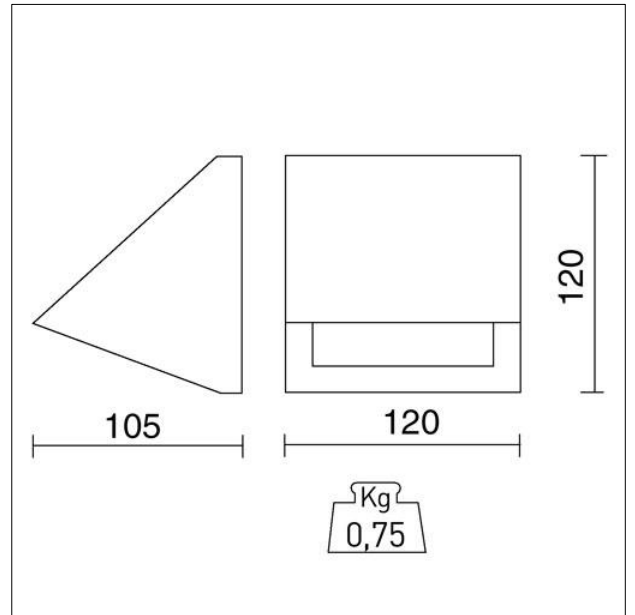

TLG_ACUTO_M_LED.wmf

Light Distribution

All values marked with an * are rated values. Thorn uses tried and tested components from leading suppliers, however there may be isolated instances of technology-related failures of individual LEDs during the rated product lifetime. International standards set the tolerance in initial flux and connected load at $\pm 10\%$. Unless stated otherwise, the values apply to an ambient temperature of 25°C.