

Areaflood Pro 2

96636357 AFP2 2L 216L50-740 A4 CL1 GY

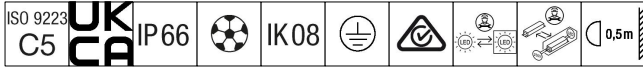

Areaflood Pro 2

A compact, lightweight, general purpose LED area floodlight. With large x 2 body. driving 216 LEDs at 500mA with Asymmetrical 40° light distribution. IP66, IK08, Class I electrical. Body: die-cast aluminium (EN AC-44300), Light grey 150 sanded textured (close to RAL9006).. Enclosure: 5mm thick toughened glass. Reversible mounting stirrup supplied, Complete with 4000K LED.

Integrated 6kV surge protection included as standard, with higher 10kV protection when selected (designated by 'SP' in the description).

Dimensions: 780 x 722 x 116 mm
 Luminaire input power: 312 W
 Luminaire luminous flux: 53823 lm
 Luminaire efficacy: 173 lm/W
 Weight: 28.1 kg
 Scx: 0.136 m²



TLG_AFP2_F_2L_1.jpg

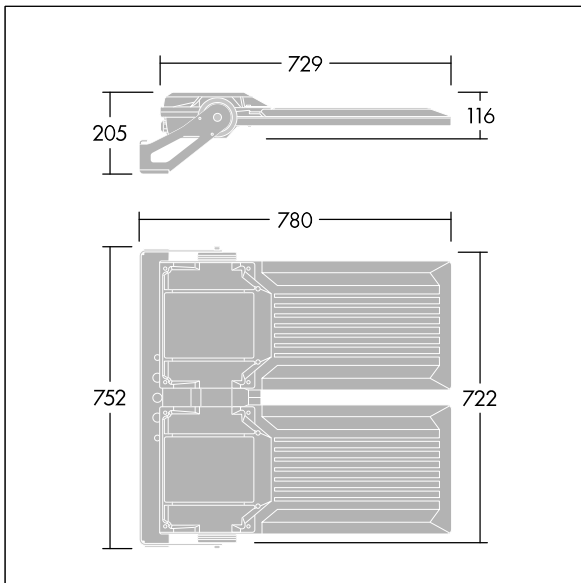

TLG_AFP2_M_2L.wmf

This product contains a light source of energy efficiency class E.

All values marked with an * are rated values. Thorn uses tried and tested components from leading suppliers, however there may be isolated instances of technology-related failures of individual LEDs during the rated product lifetime. International standards set the tolerance in initial flux and connected load at ±10%. Unless stated otherwise, the values apply to an ambient temperature of 25°C.

Areaflood Pro 2

96636357 AFP2 2L 216L50-740 A4 CL1 GY

THORN