

# Altis Gen5

THORN

96684139 ALG5 504L85-740 PST NBNBNB ANT



## Altis Gen5

A high powered LED floodlight with optic 1: narrow beam; optic 2: narrow beam; optic 3: narrow beam light distribution from 504 LEDs. External control gear (maximum driving current 850mA) and wiring with H07 RN-F cable type with mini diameter 13mm, to be ordered separately. Class I electrical, IP66, IK08. Heatsink: die-cast aluminium powder coated dark sandy grey (close to RAL 7043). Mounting bracket and frame: dark sandy grey (close to RAL 7043). Cover: 4mm clear glass. Bracket mounted using fixation points available (one M20 screw or two M14 screws). Low flicker operation (<1%) suitable for HDTV broadcasting. Complete with 4000K LED

Due to the unique calculation requirements of this product the photometric data is not provided here but design advice may be obtained from your local representative.

Dimensions: 530 x 757 x 685 mm

Luminaire input power: 1250 W

Weight: 30.9 kg

Scx: 0.4m<sup>2</sup> at 45°



TLG\_ALT5\_F\_V3.jpg

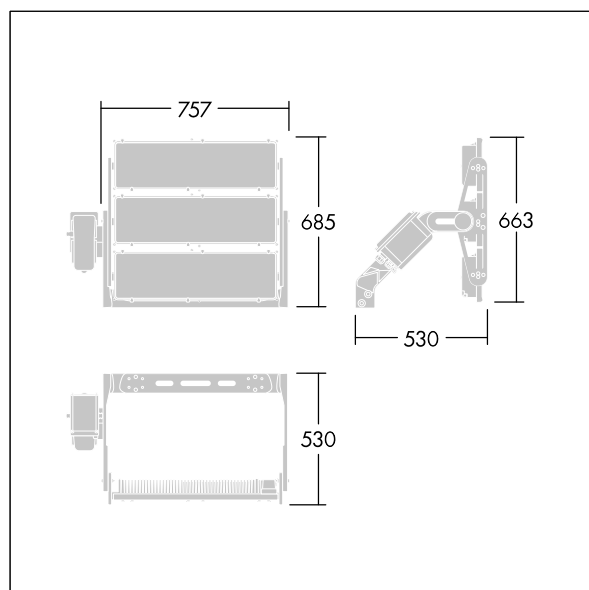

TLG\_ALT5\_M\_V3.wmf

This product contains a light source of energy efficiency class D.

All values marked with an \* are rated values. Thorn uses tried and tested components from leading suppliers, however there may be isolated instances of technology-related failures of individual LEDs during the rated product lifetime. International standards set the tolerance in initial flux and connected load at  $\pm 10\%$ . Unless stated otherwise, the values apply to an ambient temperature of 25°C.

Thorn Lighting is constantly developing and improving its products. The right is reserved to change specifications without prior notification or public announcement.  
© Thorn Lighting